



SOLUZIONI D'ARREDO PER FOOD & BEVERAGE



OMNIA



Il freddo e' il nostro habitat

ICE
VISION

ICE
VISION



una storia
di qualità
tutta italiana



Lo stile e l'affiabilità di un'esperienza decennale

IT Italproget, fondata agli inizi degli anni '80 dall'entusiasmo e dall'esperienza dei 4 soci, è oggi tra le aziende leader dei produttori italiani di vetrine refrigerate per gelati e pasticcerie e di arredamento personalizzato nell'ambito del food and beverage. Design, ricerca e qualità sono le parole chiave del successo dell'azienda ormai presente ed apprezzata in tutto il mondo: Europa, Africa, Asia, Australia, Centro America, Stati Uniti e paesi Arabi. L'azienda è portavoce e protagonista nel mondo dello stile "made in Italy", inteso come il valore che sublima lo stile, la qualità, il design, l'originalità e il gusto dei prodotti interamente realizzati in Italia. Tutta la produzione Italproget è un esempio importante di questa connotazione, apprezzata e rinomata in tutto il mondo. La missione del brand Italproget è fornire ai propri clienti prodotti e soluzioni di alto livello qualitativo, dal punto di vista tecnico, del design e del rispetto per l'ambiente. Il cliente è al centro del processo produttivo, al quale l'azienda rivolge una cura particolare e un'assistenza puntuale e precisa, in qualsiasi parte del mondo.

Stil und Zuverlässigkeit durch Erfahrung aus Jahrzehnten

DE Italproget, Anfang der 1980er Jahre aus der Begeisterung und der Erfahrung der vier Teilhaber entstanden, zählt heute zu den Herstellern von Kühlvittrinen für Speiseeis und Konditoreien sowie maßgefertigter Einrichtungen für die Gastronomiebranche. Design, Forschung und Qualität sind Schlüsselwörter des Erfolgs des Unternehmens, das nunmehr in der ganzen Welt vertreten ist und geschätzt wird: Europa, Afrika, Asien, Australien, Mittelamerika, USA und arabische Länder. Auf der ganzen Welt ist das Unternehmen Vertreter und Träger des "made in Italy", das als ein Wert verstanden wird, der den Stil, die Qualität, das Design, die Einzigartigkeit und den Schönheitssinn der vollständig in Italien hergestellten Produkte höheres Ansehen verschafft. Die gesamte Produktion von Italproget ist ein bedeutendes Beispiel dieses Stils, der in der ganzen Welt geschätzt wird. Die Mission der Marke Italproget besteht darin, Kunden Produkte und Lösungen anzubieten, die im Hinblick auf Technik, Design und Umweltschutz eine hohe Qualität aufweisen. Der Kunde steht im Mittelpunkt des Produktionsprozesses, dem das Unternehmen eine besondere Sorgfalt sowie eine pünktlichen und gewissenhaften Kundenservice auf der ganzen Welt widmet.

The style and reliability of a decade of experience

EN Italproget, founded in the early 1980's with the enthusiasm and experience of its 4 partners, is today among the leading Italian companies manufacturing refrigerated display cases for ice-cream and pastry shops as well as personalised food and beverage sector furnishings. Design, research and quality are the key words for the company's success, now operating and esteemed worldwide: Europe, Africa, Asia, Australia, Central America, the United States and Arab countries. The company is a spokesperson for and main player in the world of "made in Italy" style, a value that channels style, quality, design, originality and taste in products produced entirely in Italy. All Italproget production is an important example of this connotation, valued and renowned all over the world. The Italproget brand mission is to provide its customers with high quality products and solutions as regards the points of view of technology, design and respect for the environment. The customer is at the centre of the production process and for this reason the company dedicates special care and timely, precise assistance to them, anywhere in the world.

Le style et la fiabilité d'une expérience décennale

FR Italproget, fondée au début des années 80 par l'enthousiasme et par l'expérience de 4 associés, fait aujourd'hui partie des entreprises leader des producteurs italiens de vitrines réfrigérées pour glaces et pâtisseries et d'ameublement personnalisé dans le cadre de la restauration. Design, recherche et qualité sont les mots-clés du succès de l'entreprise désormais présente et appréciée dans le monde entier : Europe, Afrique, Asie, Australie, Amérique centrale, État-Unis et les pays Arabes. L'entreprise est porte-parole et protagoniste dans le monde du style "made in Italy", compris comme la valeur qui sublime le style, la qualité, le design, l'originalité et le goût des produits entièrement réalisés en Italie. Toute la production Italproget est un exemple important de cette connotation, appréciée et renommée dans le monde entier. La mission de la marque Italproget est de fournir à ses clients des produits et de solutions de haut niveau qualitatif, du point de vue technique, du design et du respect pour l'environnement. Le client est au centre du processus de production, auquel l'entreprise adresse un soin particulier et une assistance ponctuelle et précise, partout dans le monde.

OMNIA



Gelato



Pasticceria
Pastry
Konditorei
Pâtisserie



Pralineria
Praline
Pralinen
Pralinerie



Caldo a secco
Dry heat
Trockene Wärme
Chaud à sec



Bagno maria
Bain-marie
Wasserbad
Bain-marie

SMOOTH

IT

Uno stile minimale e duttile capace di offrire alla clientela del locale tutto ciò che serve. Questa è l'opera OMNIA di Itai Proget; una proposta completa, un concept, un modo di pensare il proprio locale, essenziale nei tratti e nel modo di porsi ma allo stesso tempo, abile nel soddisfare in maniera ottimale l'esigenza di mostrare tutti i prodotti valorizzando il loro lato migliore: SMOOTH, POZZETTI, TOPPING questi i moduli che la compongono.

EN

A minimal, ductile style able to offer customers everything they may need. This is OMNIA by Itai Proget: a complete offer, a new concept, a fresh way of looking at your establishment. With minimalist lines and way of presenting itself but, at the same time, able to fully satisfy all product display needs, enhancing their best side. This case is composed of the SMOOTH, POZZETTI, TOPPING units.



POZZETTI e TOPPING

DE

Ein minimalistischer und anpassungsfähiger Stil mit der Fähigkeit, den Kunden des Lokals all das zu bieten, was erforderlich ist. Das ist OMNIA von Ital Proget; ein komplettes Angebot, ein Konzept und eine Vision des zigen Lokals, nüchtern und wesentlich im Stil, aber gleichzeitig dazu in der Lage, auf perfekte Weise sämtliche Produkte von ihrer besten Seite zu zeigen: SMOOTH, POZZETTI, TOPPING sind die verfügbaren Modelle.

FR

Un style minimaliste et ductile en mesure d'offrir tout ce qui sert à la clientèle du lieu. Voici OMNIA, l'œuvre d'Ital Proget ; une proposition complète, un concept, une façon de penser propre lieu, un produit essentiel dans les traits et dans la manière de se placer mais au même moment habile à satisfaire de la meilleure façon qu'il soit, l'exigence de montrer tous les produits en valorisant leur meilleur côté : SMOOTH, POZZETTI, TOPPING sont les modules qui la composent.

SMOOTH Gelato



REFRIGERAZIONE VENTILATA
VENTILATED REFRIGERATION
UMLUFTKÜHLUNG
RÉFRIGÉRATION VENTILÉE

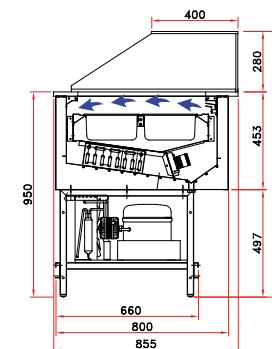

Base / Basic
Basis / Base

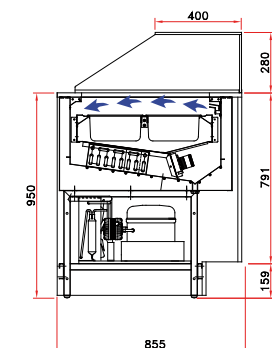

Pannellata / With panels
Mit Paneelen / Avec des panneaux

DATI TECNICI / TECHNICAL DATA / TECHNISCHE DATEN / DONNEES TECHNIQUES

MOD.										Tensione Supply Spannung Tension	Regime Output Verhältnis Régime	Sbrinamento In Defrost Zeitgesteuerte Dégivrage	N. Classe climatica No. Climate class Klimaklasse N° Classe climatique N°
	L	P	H	kg	L	P	H	kg					
SMOOTH GELATO 100	100	85	123	156	122	98	150	196	-16 / -18	230/1/50	0.8	1.05	3 (25/60)
SMOOTH GELATO 125	125	85	123	160	137	98	150	200	-16 / -18	230/1/50	0.9	1.43	3 (25/60)
SMOOTH GELATO 150	150	85	123	200	172	98	150	240	-16 / -18	230/1/50	1.2	1.43	3 (25/60)
SMOOTH GELATO 200	200	85	123	260	224	98	150	300	-16 / -18	230/1/50	1.2	2.19	3 (25/60)

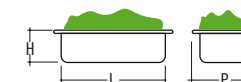

L x P x H
260 x 160 x 120 [3,4Lt.]
360 x 165 x 120 [5Lt.]
530 x 165 x 110 [7Lt.]



SMOOTH GELATO 100

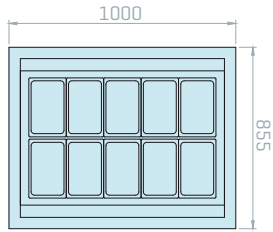

10 vaschette / containers
(260x160) schalen / barquettes

SMOOTH GELATO 125

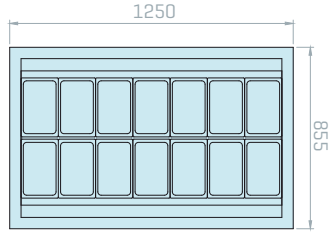

14 vaschette / containers
(260x160) schalen / barquettes

SMOOTH GELATO 150

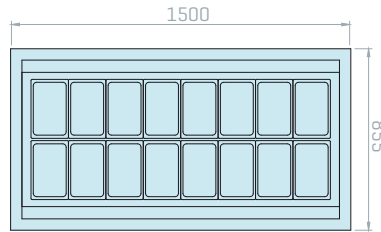

16 vaschette / containers
(260x160) schalen / barquettes

SMOOTH GELATO 200

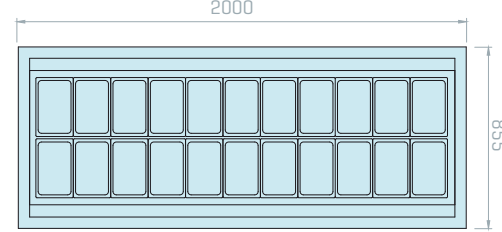

22 vaschette / containers
(260x160) schalen / barquettes

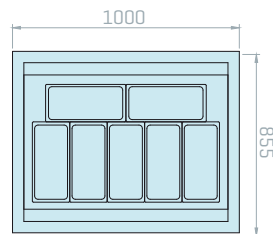

7 vaschette / containers
(360x165) schalen / barquettes

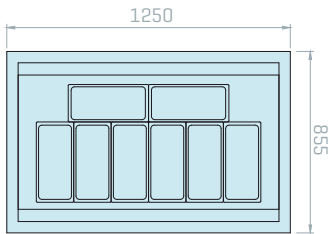

8 vaschette / containers
(360x165) schalen / barquettes

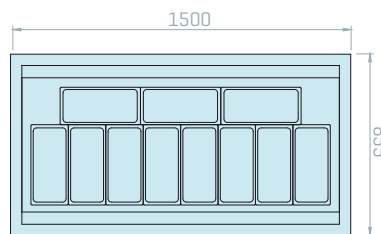

11 vaschette / containers
(360x165) schalen / barquettes

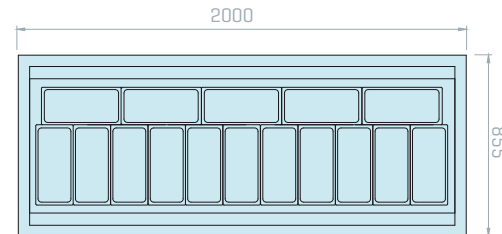

16 vaschette / containers
(360x165) schalen / barquettes

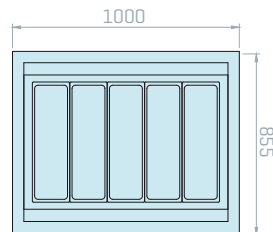

5 vaschette / containers
(530x165) schalen / barquettes

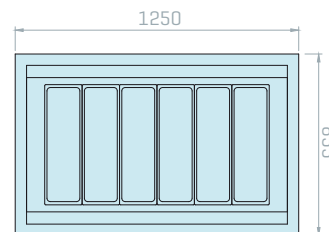

6 vaschette / containers
(530x165) schalen / barquettes

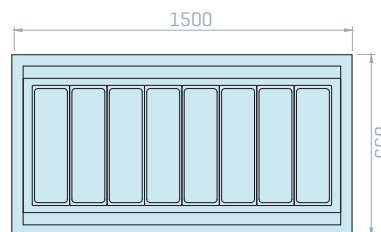

8 vaschette / containers
(530x165) schalen / barquettes

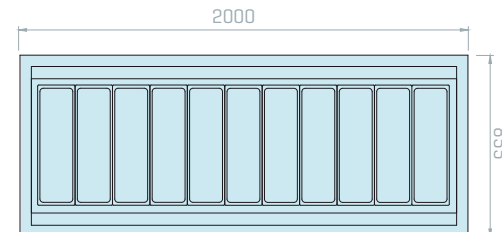

11 vaschette / containers
(530x165) schalen / barquettes

DI SERIE / STANDARD / DI SERIE / SÉRIE

Sbrinamento auto. elettr. / Automatic electric defrost / Zeitgesteuerte abtauautomatik / Dégivrage automatique
 Unita' di controllo elettr. / Electronic control unit / Elektronische steuereinheit / Unité de contrôle électronique
 Fluido refrigerante R404A / R404A refrigerant gas / Kühlgas R404A / Gaz réfrigérant R404A

COLORI / COLOURS / FARBEN / COULEURS



Le vetrine possono essere personalizzate nei colori RAL in commercio.
 The showcase can be customized in colors according to available RAL.
 Die Vitrinen können in handelsüblichen RAL-Farben gestaltet werden.
 Les vitrines peuvent être personnalisées selon les coloris RAL dans le commerce.

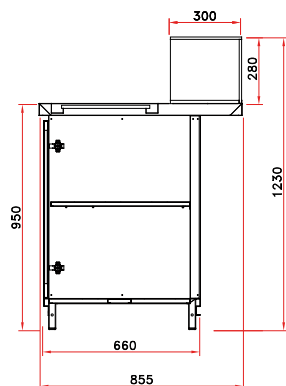

Base / Basic
Basis / Base

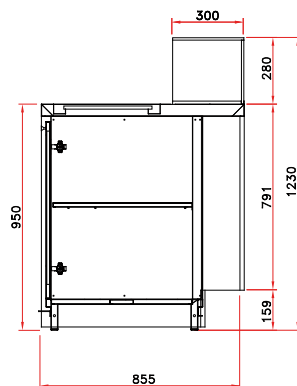

Pannellata / With panels
Mit Paneelen / Avec des panneaux

SMOOTH MGD

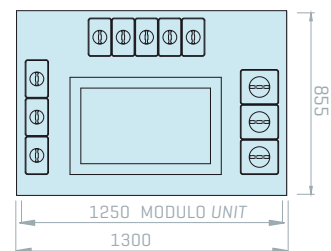

COLORI / COLOURS / FARBEN / COULEURS



Le vetrine possono essere personalizzate nei colori RAL in commercio.
The showcase can be customized in colors according to available RAL.
Die Vitrinen können in handelsüblichen RAL-Farben gestaltet werden.
Les vitrines peuvent être personnalisées selon les coloris RAL dans le commerce.

SMOOTH

Pasticceria / Pastry / Konditorei / Pâtisserie



REFRIGERAZIONE CON FLUSSO SOFT
REFRIGERATED WITH SOFT FLOW SYSTEM
KÜHLUNG MIT SOFT-FLOW-SYSTEM
RÉFRIGÉRATION AVEC FLUX SOFT

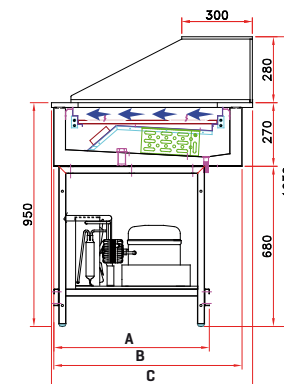

Base / Basic
Basis / Base

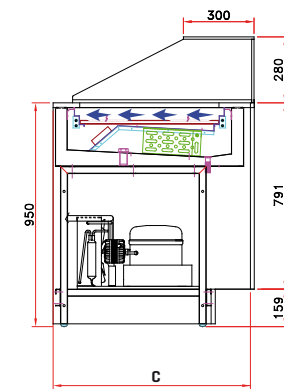

Pannellata / With panels
Mit Paneelen / Avec des panneaux

DATI TECNICI / TECHNICAL DATA / TECHNISCHE DATEN / DONNEES TECHNIQUES

MOD.										Tensione Supply Spannung Tension	Regime Output Verhältnis Régime	N. Classe climatica No. Climate class Klimaklasse N° Classe climatique N°
	L [cm]	P [cm]	H [cm]	kg	L [cm]	P [cm]	H [cm]	kg				
SMOOTH PAST 100	100	C	123	150	122	128	150	190	+2 / +4	230/1/50	0.42	3 (25/60)
SMOOTH PAST 125	125	C	123	154	137	128	150	194	+2 / +4	230/1/50	0.48	3 (25/60)
SMOOTH PAST 150	150	C	123	195	172	128	150	235	+2 / +4	230/1/50	0.76	3 (25/60)
SMOOTH PAST 200	200	C	123	254	224	128	150	294	+2 / +4	230/1/50	0.8	3 (25/60)
SMOOTH PAST 250	250	C	123	315	274	128	150	355	+2 / +4	230/1/50	1.15	3 (25/60)

Profondità / Depth / Tiefe / Profondeur (cm)

A	660	800	1000
B	800	940	1140
C	855	995	1195

H123

SMOOTH PAST 100

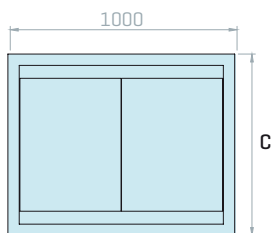

SMOOTH PAST 125

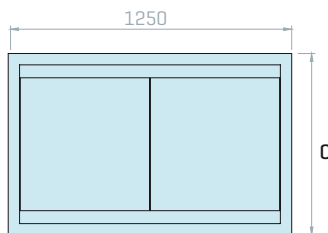

SMOOTH PAST 150

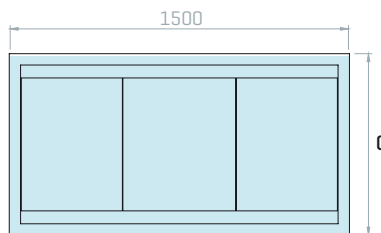

SMOOTH PAST 200

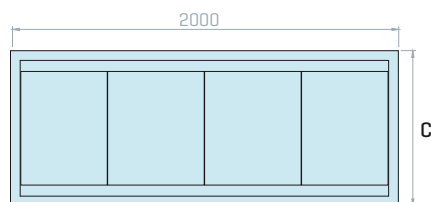

SMOOTH PAST 250

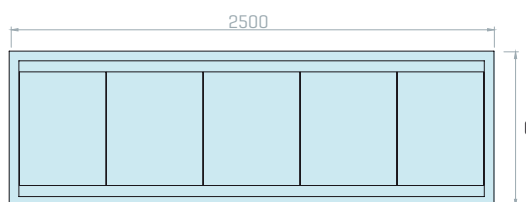

H122

con Riserva / with Storage / mit Reserve / avec Réserve

SMOOTH PAST 150 S

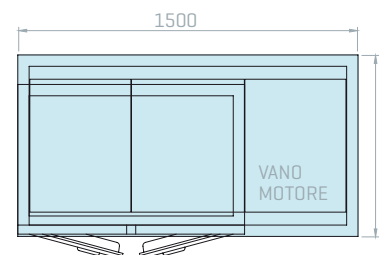

SMOOTH PAST 200 S

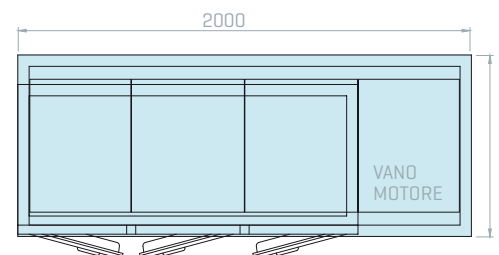

SMOOTH PAST 250 S

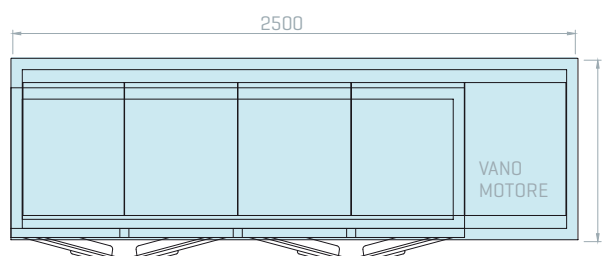

DI SERIE / STANDARD / DI SERIE / SÉRIE

Sbrinamento auto. elettr. / Automatic electric defrost / Zeitgesteuerte abtauautomatik / Dégivrage automatique
Unità di controllo elettr. / Electronic control unit / Elektronische steuereinheit / Unité de contrôle électronique
Fluido refrigerante R404A / R404A refrigerant gas / Kühlgas R404A / Gaz réfrigérant R404A

COLORI / COLOURS / FARBEN / COULEURS



Le vetrine possono essere personalizzate nei colori RAL in commercio.
The showcase can be customized in colors according to available RAL.
Die Vitrinen können in handelsüblichen RAL-Farben gestaltet werden.
Les vitrines peuvent être personnalisées selon les coloris RAL dans le commerce.

SMOOTH

Caldo a secco / Dry heat / Trockene Wärme / Chaud à sec

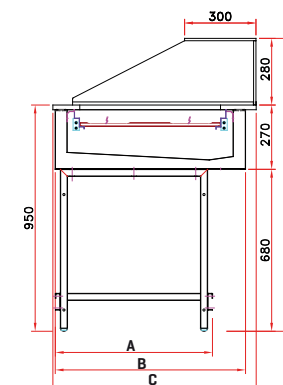

Base / Basic
Basis / Base

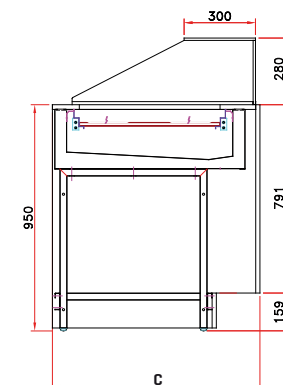

Pannellata / With panels
Mit Paneelen / Avec des panneaux

DATI TECNICI / TECHNICAL DATA / TECHNISCHE DATEN / DONNEES TECHNIQUES

MOD.									 [°C]	Tensione Supply Spannung Tension [V/hz]	Regime Output Verhältnis Régime [Kw]	N. Classe climatica No. Climate class Klimaklasse N° Classe climatique N° [C°%UR]
	L	P	H	kg	L	P	H	kg				
SMOOTH CS 100	100	C	123	130	124	128	138	169	+40 / +60	230/1/50	0.6	-
SMOOTH CS 125	125	C	123	134	124	128	138	173	+40 / +60	230/1/50	0.6	-
SMOOTH CS 150	150	C	123	175	175	128	138	212	+40 / +60	230/1/50	1.2	-
SMOOTH CS 200	200	C	123	215	224	128	138	252	+40 / +60	230/1/50	1.8	-
SMOOTH CS 250	250	C	123	215	274	128	138	310	+40 / +60	230/1/50	2.4	-

Profondità / Depth / Tiefe / Profondeur (cm)

A	660	800	1000
B	800	940	1140
C	855	995	1195

SMOOTH CS 100

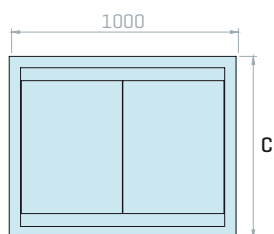

SMOOTH CS 125

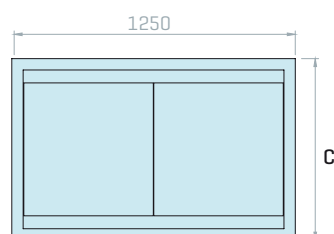

SMOOTH CS 150

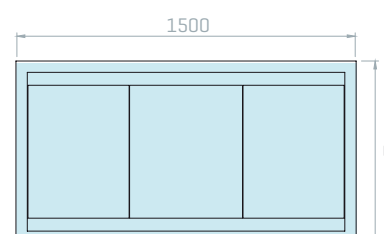

SMOOTH CS 200

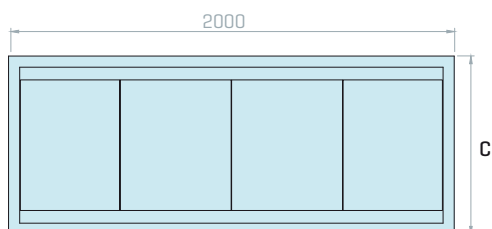

SMOOTH CS 250

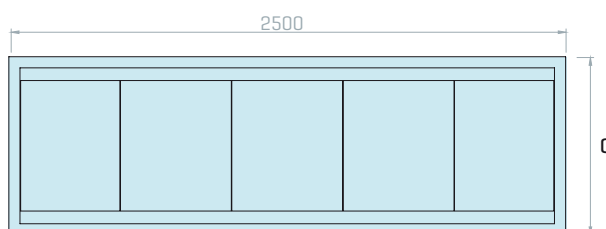

DI SERIE / STANDARD / DI SERIE / SÉRIE

Unità di controllo elettr. / Electronic control unit / Elektronische steuereinheit / Unité de contrôle électronique

COLORI / COLOURS / FARBEN / COULEURS



Le vetrine possono essere personalizzate nei colori RAL in commercio.
The showcase can be customized in colors according to available RAL.
Die Vitrinen können in handelsüblichen RAL-Farben gestaltet werden.
Les vitrines peuvent être personnalisées selon les coloris RAL dans le commerce.

SMOOTH

Bagno maria / Bain marie / Wasserbad / Bain-marie

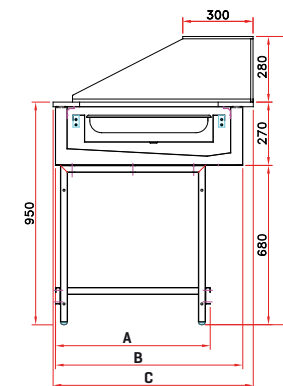

Base / Basic
Basis / Base

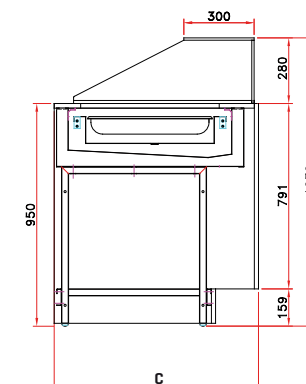

Pannellata / With panels
Mit Paneelen / Avec des panneaux

DATI TECNICI / TECHNICAL DATA / TECHNISCHE DATEN / DONNEES TECHNIQUES

MOD.										Tensione Supply Spannung Tension	Regime Output Verhältnis Régime	N. Classe climatica No. Climate class Klimaklasse N° Classe climatique N°
	L	P	H	[kg]	L	P	H	[kg]				
SMOOTH BM 100	100	C	123	130	124	128	138	169	+40 / +90	230/1/50	1.5	-
SMOOTH BM 125	125	C	123	134	124	128	138	173	+40 / +90	230/1/50	1.5	-
SMOOTH BM 150	150	C	123	175	175	128	138	212	+40 / +90	230/1/50	2.4	-
SMOOTH BM 200	200	C	123	215	224	128	138	252	+40 / +90	230/1/50	3	-
SMOOTH BM 250	250	C	123	215	274	128	138	310	+40 / +90	230/1/50	4.5	-

Profondità / Depth / Tiefe / Profondeur (cm)

A	660	800	1000
B	800	940	1140
C	855	995	1195

SMOOTH BM 100

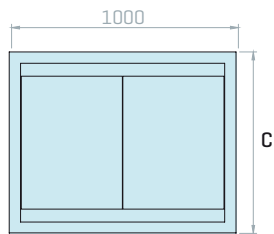

SMOOTH BM 125

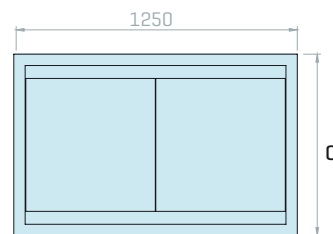

SMOOTH BM 150

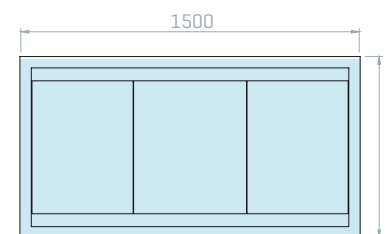

SMOOTH BM 200

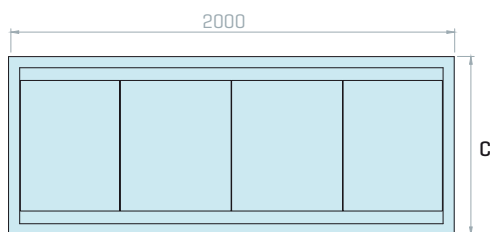

SMOOTH BM 250

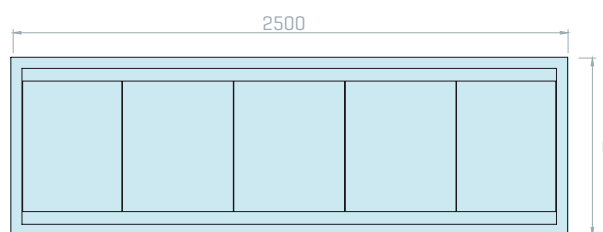

VASCHETTE / CONTAINERS / SCHALEN / BARQUETTES

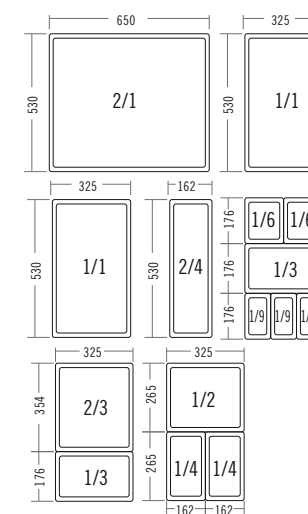

NOTE NOTE / NOTE / NOTE

Piani forati e vaschette ESCLUSE / Perforated bases and containers EXCLUDED
 Gelochte ebenen und schalen AUSGESCHLOSSEN / Plans perforés et barquettes EXCLUS

DI SERIE / STANDARD / DI SERIE / SÉRIE

Unità di controllo elettr. / Electronic control unit / Elektronische steuereinheit / Unité de contrôle électronique

COLORI / COLOURS / FARBEN / COULEURS



Le vetrine possono essere personalizzate nei colori RAL in commercio.
 The showcase can be customized in colors according to available RAL.
 Die Vitrinen können in handelsüblichen RAL-Farben gestaltet werden.
 Les vitrines peuvent être personnalisées selon les coloris RAL dans le commerce.

SMOOTH

Banco cassa / Cash counter / Thekenkasse / Comptoir caisse

H95

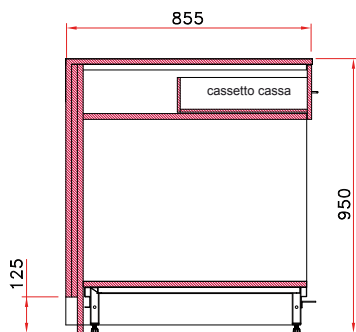

Pannellata / With panels
Mit Paneelen / Avec des panneaux

SMOOTH CASSA 60

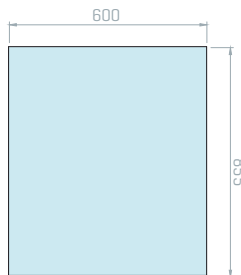

SMOOTH CASSA 80

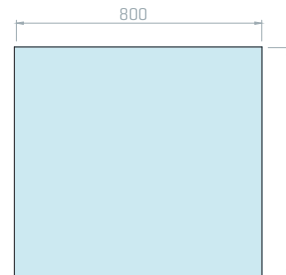

SMOOTH CASSA 100

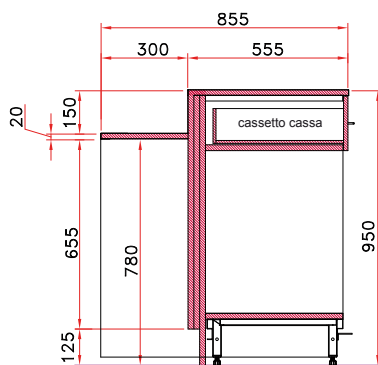
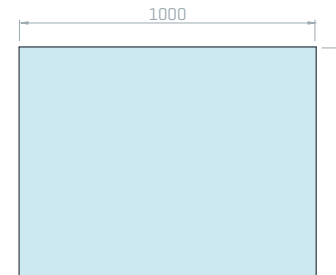

Pannellata / With panels
Mit Paneelen / Avec des panneaux

SMOOTH CASSA 60

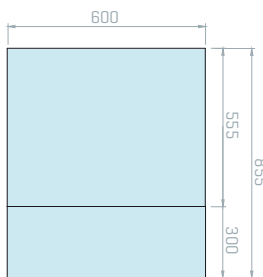

SMOOTH CASSA 80

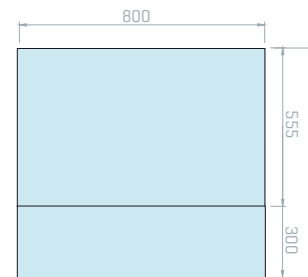

SMOOTH CASSA 100

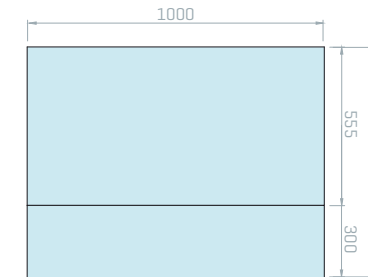

H122 Neutro / Neutral / Neutral / Neutre

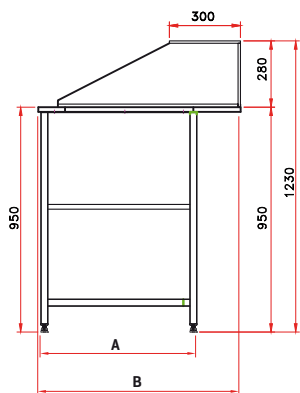

Base / Basic
Basis / Base

SMOOTH NEUTRO 100

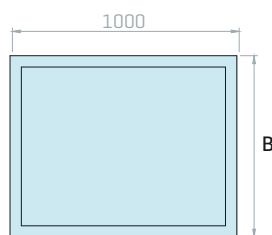

SMOOTH NEUTRO 125

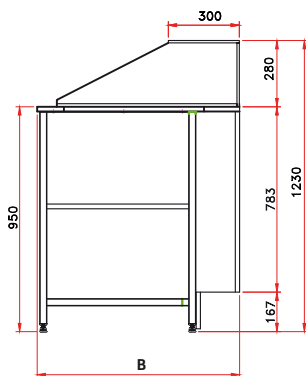
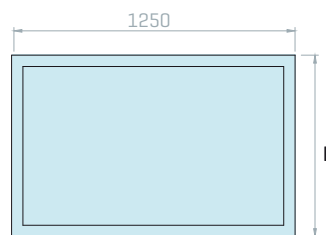

Pannellata / With panels
Mit Paneelen / Avec des panneaux

SMOOTH NEUTRO 150

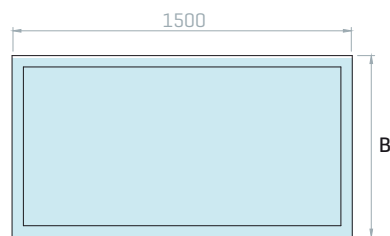

Profondità / Depth / Tiefe / Profondeur (cm)

A	660	800	1000
B	855	995	1195

COLORI / COLOURS / FARBEN / COULEURS



Le vetrine possono essere personalizzate nei colori RAL in commercio.
The showcase can be customized in colors according to available RAL.
Die Vitrinen können in handelsüblichen RAL-Farben gestaltet werden.
Les vitrines peuvent être personnalisées selon les coloris RAL dans le commerce.



DATI TECNICI / TECHNICAL DATA / TECHNISCHE DATEN / DONNEES TECHNIQUES

MOD.										Tensione Supply Spannung Tension	Regime Output Verhältnis Régime	Potenza assorbita Electrical power output Absorbierte Leistung Puissance absorbée	N. Classe climatica No. Climate class Klimaklasse N° Classe climatique N°
	L [cm]	P [cm]	H [cm]	[kg]	L [cm]	P [cm]	H [cm]	[kg]					
CARAPINE 75	75	73	95 / 123	-	125	98	150	-	-5 / -18	230/1/50	0.4	1.48	4+(32/60)
CARAPINE 100	100	73	95 / 123	-	125	98	150	-	-5 / -18	230/1/50	0.5	3.1	4+(32/60)
CARAPINE 125	125	73	95 / 123	-	125	98	150	-	-5 / -18	230/1/50	0.56	3.1	4+(32/60)
CARAPINE 150	150	73	95 / 123	-	172	98	150	-	-5 / -18	230/1/50	0.6	3.7	4+(32/60)
CARAPINE 175	175	73	95 / 123	-	224	98	150	-	-5 / -18	230/1/50	0.64	4.1	4+(32/60)
CARAPINE 75	75	73	95 / 123	-	125	98	150	-	-5 / -18	230/1/50	0.85	4.1	4+(32/60)
CARAPINE 100	100	73	95 / 123	-	125	98	150	-	-5 / -18	230/1/50	1.02	5.1	4+(32/60)
CARAPINE 125	125	73	95 / 123	-	125	98	150	-	-5 / -18	230/1/50	1.1	6.5	4+(32/60)
CARAPINE 150	150	73	95 / 123	-	172	98	150	-	-5 / -18	230/1/50	1.1	6.5	4+(32/60)
CARAPINE 175	175	73	95 / 123	-	224	98	150	-	-5 / -18	230/1/50	1.37	6.5	4+(32/60)

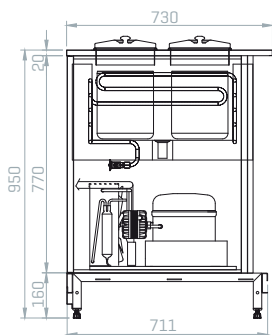

Base / Basic
Basis / Base

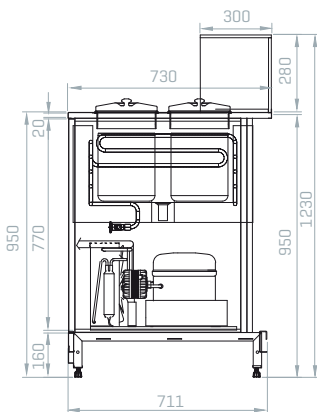

Pannellata / With panels
Mit Paneelen / Avec des panneaux

CARAPINE 75

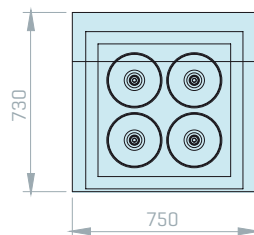

CARAPINE 100

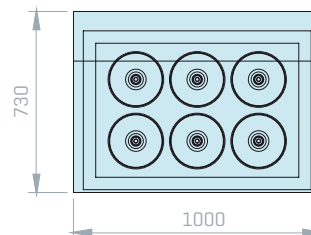

CARAPINE 125

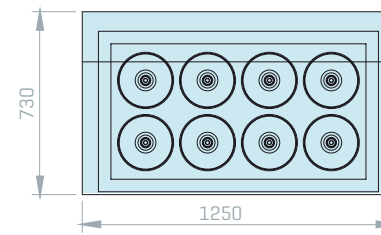

CARAPINE 150

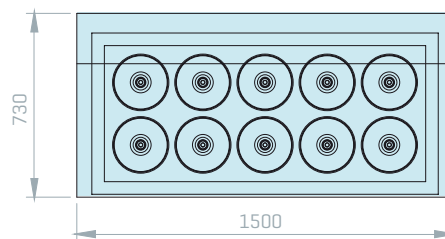

CARAPINE 175

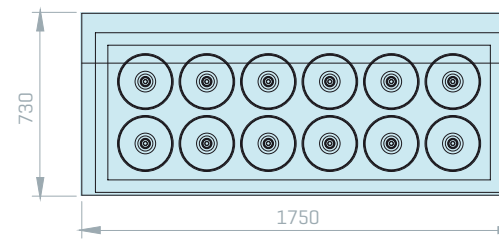

COLORI / COLOURS / FARBEN / COULEURS



Le vetrine possono essere personalizzate nei colori RAL in commercio.
The showcase can be customized in colors according to available RAL.
Die Vitrinen können in handelsüblichen RAL-Farben gestaltet werden.
Les vitrines peuvent être personnalisées selon les coloris RAL dans le commerce.



DATI TECNICI / TECHNICAL DATA / TECHNISCHE DATEN / DONNEES TECHNIQUES

MOD.										Resa frigo Refrigeration power Kühlschrank Ausbeute Rendement frigo	Tensione Supply Spannung Tension	Regime Output Verhältnis Régime	Potenza assorbita Electrical power output Absorbierte Leistung Puissance absorbée	N. Classe climatica No. Climate class Klimaklasse N° Classe climatique N°
	L	P	H	[kg]	L	P	H	[kg]						
CARAPINE 75BX	75	73	95 / 123	-	125	98	150	-	-5 / -18	-	230/1/50	0.4	3.1	4+(32/60)
CARAPINE 100BX	100	73	95 / 123	-	125	98	150	-	-5 / -18	-	230/1/50	0.6	3.1	4+(32/60)
CARAPINE 125BX	125	73	95 / 123	-	125	98	150	-	-5 / -18	-	230/1/50	0.9	3.7	4+(32/60)
CARAPINE 150BX	150	73	95 / 123	-	172	98	150	-	-5 / -18	-	230/1/50	1.09	4.8	4+(32/60)
CARAPINE 175BX	175	73	95 / 123	-	224	98	150	-	-5 / -18	-	230/1/50	1.37	5.1	4+(32/60)
CARAPINE 75BX	75	73	95 / 123	-	125	98	150	-	-5 / -18	-	230/1/50	0.85	4.1	4+(32/60)
CARAPINE 100BX	100	73	95 / 123	-	125	98	150	-	-5 / -18	-	230/1/50	1.02	5.1	4+(32/60)
CARAPINE 125BX	125	73	95 / 123	-	125	98	150	-	-5 / -18	-	230/1/50	1.1	6.5	4+(32/60)
CARAPINE 150BX	150	73	95 / 123	-	172	98	150	-	-5 / -18	-	230/1/50	1.1	6.5	4+(32/60)
CARAPINE 175BX	175	73	95 / 123	-	224	98	150	-	-5 / -18	-	230/1/50	1.37	6.5	4+(32/60)



STATICA
STATIC
STATISCH
STATIQUE



VENTILATA
VENTILATED
UMLUFT
VENTILÉE



GLICOLE
GLYCOL
GLYKOL
GLYCOL

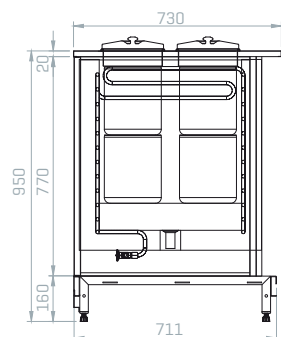

Base / Basic
Basis / Base

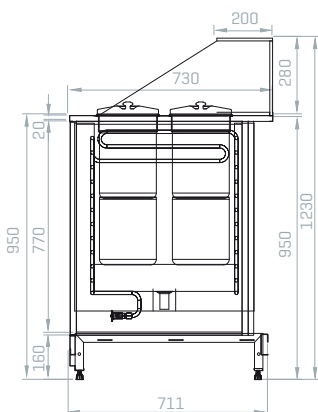

Pannellata / With panels
Mit Paneelen / Avec des panneaux

CARAPINE 75BX

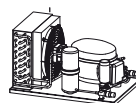
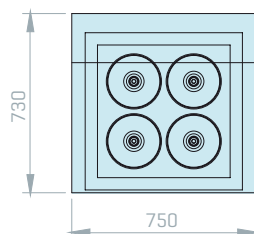

CARAPINE 100BX

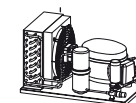
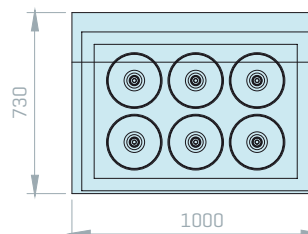

CARAPINE 125BX

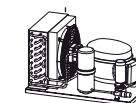
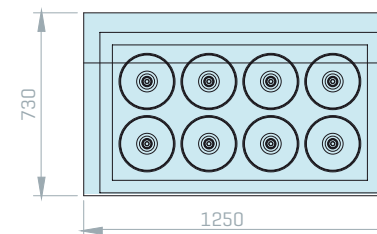

CARAPINE 150BX

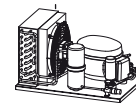
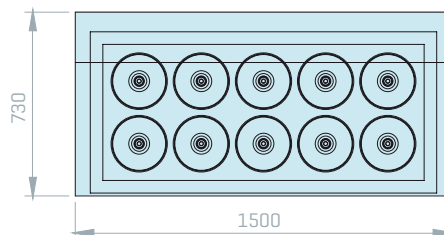

CARAPINE 175BX

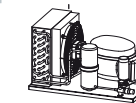
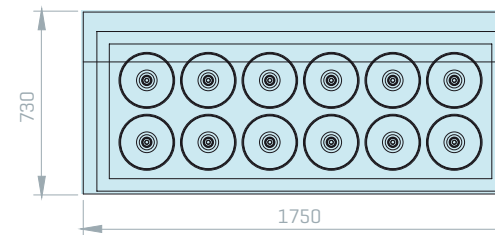



COLORI / COLOURS / FARBEN / COULEURS



Le vetrine possono essere personalizzate nei colori RAL in commercio.
The showcase can be customized in colors according to available RAL.
Die Vitrinen können in handelsüblichen RAL-Farben gestaltet werden.
Les vitrines peuvent être personnalisées selon les coloris RAL dans le commerce.

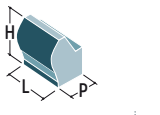

DATI TECNICI / TECHNICAL DATA / TECHNISCHE DATEN / DONNEES TECHNIQUES

MOD.										Resa frigo Refrigeration power Kühlschrank Ausbeute Rendement frigo [Kw]	Tensione Supply Spannung Tension [V/Hz]	Regime Output Verhältnis Régime [Kw]	Potenza assorbita Electrical power output Absorbierte Leistung Puissance absorbée [Kw]	N. Classe climatica No. Climate class Klimaklasse N° Classe climatique N° [C°/%UR]
	L	P	H	kg	L	P	H	kg						
	[cm]	[cm]	[cm]	[kg]	[cm]	[cm]	[cm]	[kg]						
CARAPINE 125B	125	73	95 / 123	-	125	98	150	-	-5 / -18	-	230/1/50	0.4	3.1	4+(32/60)
CARAPINE 150B	150	73	95 / 123	-	172	98	150	-	-5 / -18	-	230/1/50	0.6	3.1	4+(32/60)
CARAPINE 175B	175	73	95 / 123	-	224	98	150	-	-5 / -18	-	230/1/50	0.9	3.7	4+(32/60)
CARAPINE 200B	200	73	95 / 123	-	224	98	150	-	-5 / -18	-	230/1/50	1.09	4.8	4+(32/60)
CARAPINE 225B	225	73	95 / 123	-	224	98	150	-	-5 / -18	-	230/1/50	1.37	5.1	4+(32/60)
CARAPINE 125B	125	73	95 / 123	-	125	98	150	-	-5 / -18	-	230/1/50	0.85	4.1	4+(32/60)
CARAPINE 150B	150	73	95 / 123	-	172	98	150	-	-5 / -18	-	230/1/50	1.02	5.1	4+(32/60)
CARAPINE 175B	175	73	95 / 123	-	224	98	150	-	-5 / -18	-	230/1/50	1.1	6.5	4+(32/60)
CARAPINE 200B	200	73	95 / 123	-	224	98	150	-	-5 / -18	-	230/1/50	1.1	6.5	4+(32/60)
CARAPINE 225B	225	73	95 / 123	-	224	98	150	-	-5 / -18	-	230/1/50	1.37	6.5	4+(32/60)



STATICA
STATIC
STATISCH
STATIQUE



VENTILATA
VENTILATED
UMLUFT
VENTILÉE



GLICOLE
GLYCOL
GLYKOL
GLYCOL

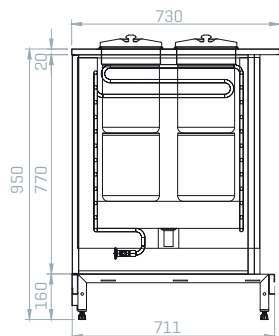

Base / Basic
Basis / Base

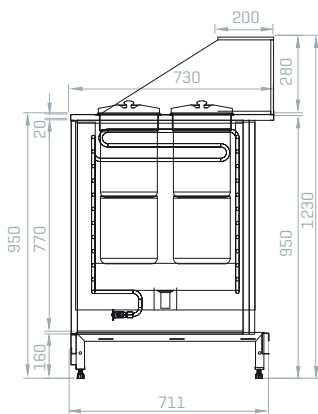

Pannellata / With panels
Mit Paneelen / Avec des panneaux

CARAPINE 125B

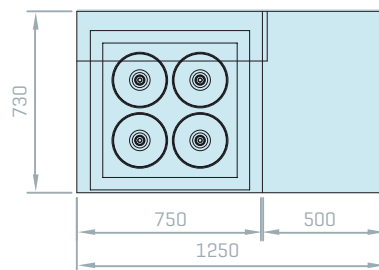

CARAPINE 150B

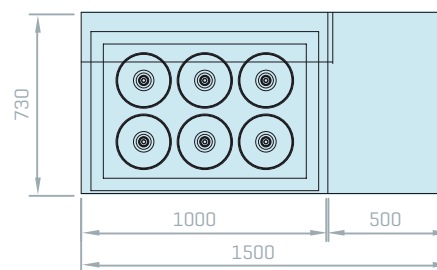

CARAPINE 175B

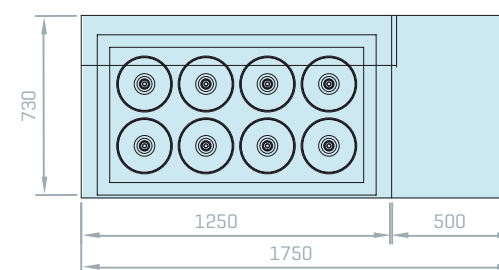

CARAPINE 200B

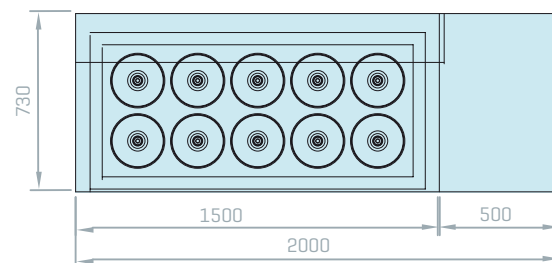

CARAPINE 225B

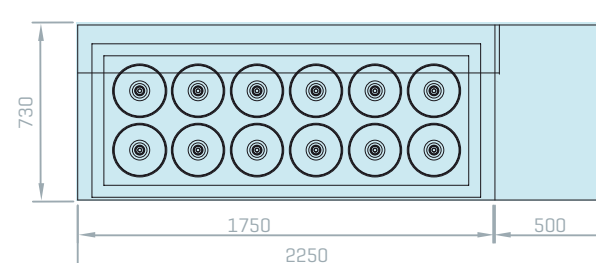

COLORI / COLOURS / FARBEN / COULEURS



Le vetrine possono essere personalizzate nei colori RAL in commercio.
The showcase can be customized in colors according to available RAL.
Die Vitrinen können in handelsüblichen RAL-Farben gestaltet werden.
Les vitrines peuvent être personnalisées selon les coloris RAL dans le commerce.

TOPPING

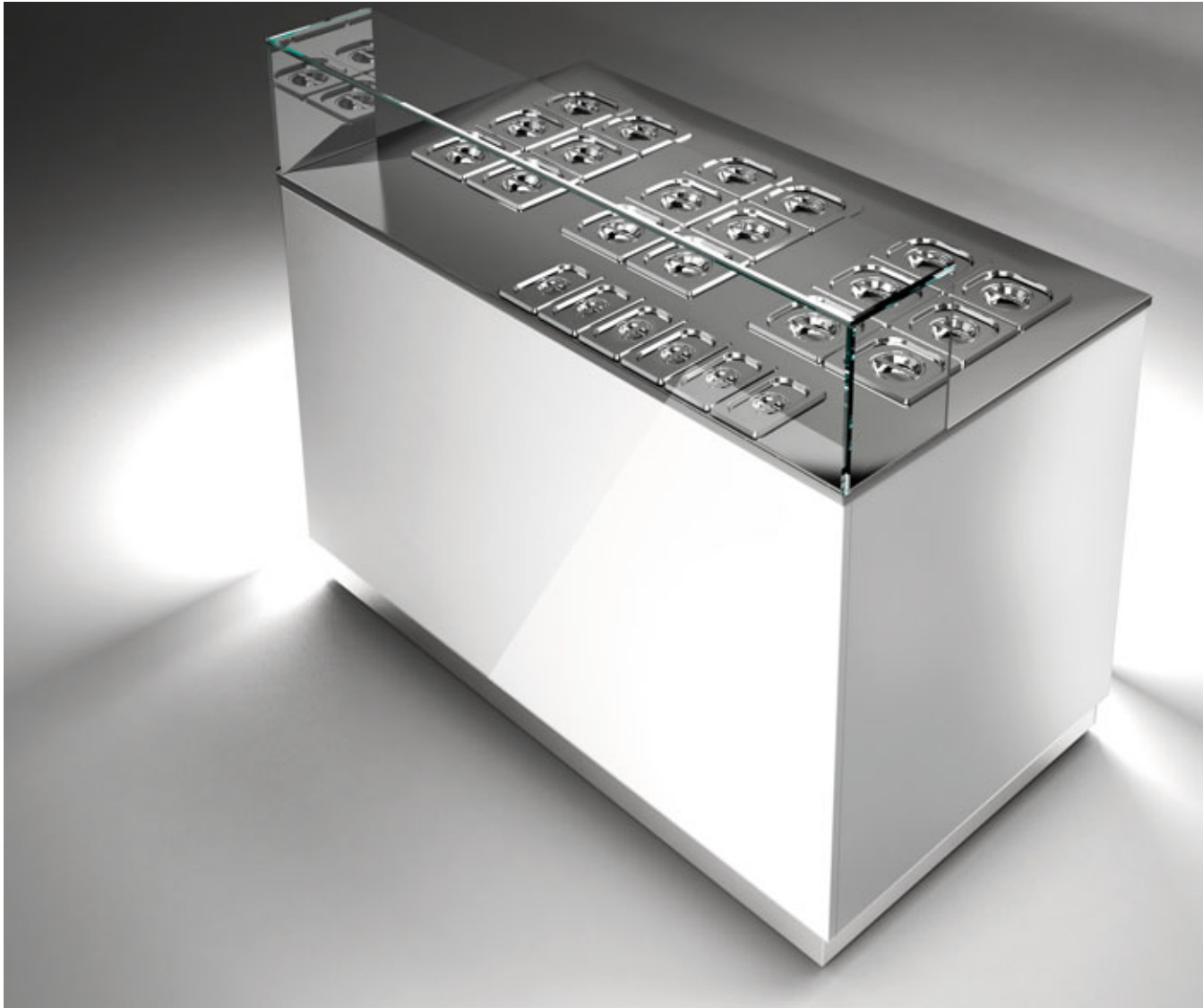

Cella Frigo	+2 / +4°C
Vaschette refrigerate per salse e frutta	+2 / +4°C
Vaschette riscaldate per salse calde	+40 / +60°C
Vaschette temperatura ambiente	

Struttura completamente in INOX AISI304.
Versioni: con refrigerazione TN ventilata, con refrigerazione TN statica, calda a bagno maria, calda a secco, neutra.
U.C. a bordo per la versione refrigerata.

Cold store	+2 / +4°C
Refrigerated trays for sauces and fruit	+2 / +4°C
Heated trays for hot sources	+40 / +60°C
Trays at room temperature	

Support structure completely in s/s AISI304.
Versions: ventilated refrigeration TN, static refrigeration TN, bain-marie hot food, dry heat food, ambient.
Internal condensing unit for refrigerated version.

Kühlzelle	+2 / +4°C
Gekühlte Schalen für Saucen und Früchte	+2 / +4°C
Erwärmte Schalen für warme Saucen	+40 / +60°C
Schalen in Umgebungstemperatur	

Konstruktion vollständig aus EDELSTAHL AISI304.
Ausführungen: mit TN-Kühlung mit Umluft, mit statischer TN-Kühlung, Erwärmung mit Wasserbad, Trockenerwärmung, neutral.
V.E. für Kühlversion angebaut.

Chambre Froide	+2 / +4°C
Barquettes réfrigérées pour sauces et fruits	+2 / +4°C
Barquettes réchauffées pour sauces chaudes	+40 / +60°C
Barquettes température ambiante	

Structure entièrement en INOX AISI304.
Versions : avec réfrigération TN (température négative) ventilée, avec réfrigération TN statique, chaude à bain-marie, chaude à sec, neutre.
U.C. (unité de condensation) à bord pour la version réfrigérée.

Neutro / Neutral / Neutral / Neutre

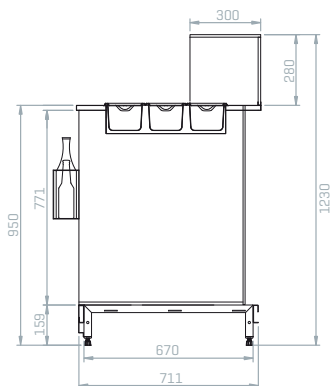

Base / Basic
Basis / Base

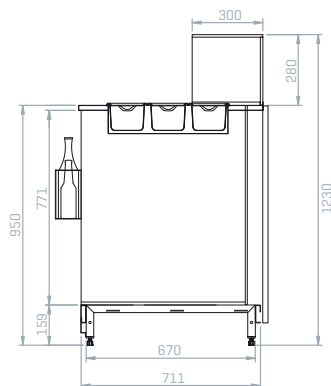

Pannellata / With panels
Mit Paneelen / Avec des panneaux

Struttura completamente in acciaio inox AISI 304.
Piano di lavoro predisposto per vaschette e coperchi gastronom.
Tasca inox per salse in bottiglia.

ESCLUSO: teca vetro, rivestimento in legno laccato, illuminazione LED sul frontale, vaschette gastronom.

Structure completely in S/s AISI304.
Work top ready for gastronorm lids and containers. Bags in S/s for topping bottles.

NOT INCLUDED: glass case, lacquered wood cover, frontal LED lights, gastronorm containers.

Struktur vollständig aus Edelstahl AISI 304.
Arbeitsplatte für Gastronorm-Schalen und -Deckel vorbereitet.
Edelstahltasche für Saucen in Flaschen.

AUSGENOMMEN: Glastheke, Verkleidung aus lackiertem Holz, LED-Beleuchtung an der Frontseite, Gastronorm-Schalen.

Structure entièrement en acier inox AISI 304.
Plan de travail prévu pour les barquettes et les couvercles gastronom. Poche inox pour sauces en bouteille.

EXCLUS : vitrine, revêtement en bois laqué, éclairage LED sur la façade, barquettes gastronom.

TOPPING NEUTRO 100

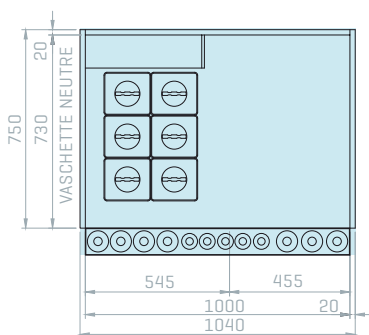

COLORI / COLOURS / FARBEN / COULEURS



Le vetrine possono essere personalizzate nei colori RAL in commercio.
The showcase can be customized in colors according to available RAL.
Die Vitrinen können in handelsüblichen RAL-Farben gestaltet werden.
Les vitrines peuvent être personnalisées selon les coloris RAL dans le commerce.

TOPPING

Frigo Junior / Junior Frigo / Kühlschrank Junior / Frigo Junior

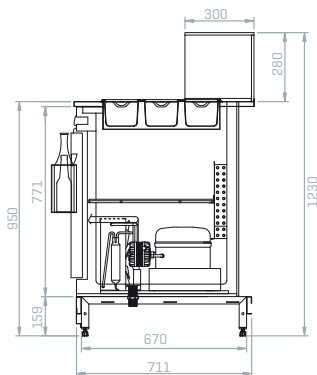

Base / Basic
Basis / Base

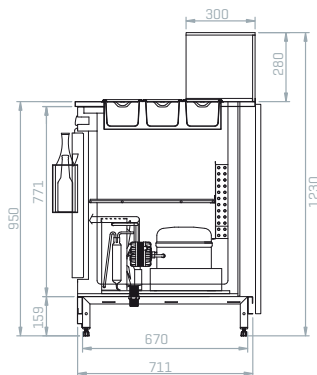

Pannellata / With panels
Mit Paneelen / Avec des panneaux

TOPPING 100

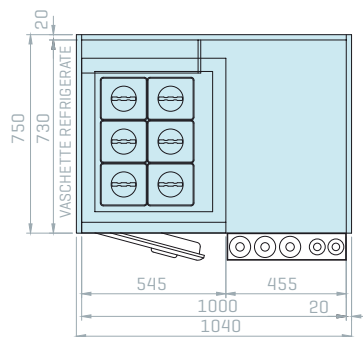

Struttura completamente in acciaio inox AISI 304. Piano di lavoro predisposto per vaschette e coperchi gastronorm. Tasca inox per salse in bottiglia. Cella frigo sottostante TN ventilata.

ESCLUSO: teca vetro, rivestimento in legno laccato, illuminazione LED sul frontale, vaschette gastronorm.

Structure completely in S/s AISI304.
Work top ready for gastronorm lids and containers. Bags in S/s for topping bottles. Ventilated refrigerated cell in NT.

NOT INCLUDED: glass case, lacquered wood cover, frontal LED lights, gastronorm containers.

Struktur vollständig aus Edelstahl AISI 304. Arbeitsplatte für Gastronorm-Schalen und -Deckel vorbereitet. Edelstahltasche für Saucen in Flaschen. Umluft-Kühlzelle unter TN

AUSGENOMMEN: Glasheke, Verkleidung aus lackiertem Holz, LED-Beleuchtung an der Frontseite, Gastronorm-Schalen.

Structure entièrement en acier inox AISI 304. Plan de travail prévu pour les barquettes et les couvercles gastronorm. Poche inox pour sauces en bouteille. Chambre froide dessous TN (température négative) ventilée.

EXCLUS : vitrine, revêtement en bois laqué, éclairage LED sur la façade, barquettes gastronorm.

Frigo Caldo e Neutro / Frigo, Hot and Neutral / Kühlschrank Warm und Neutral / Frigo Chaud et Neutre

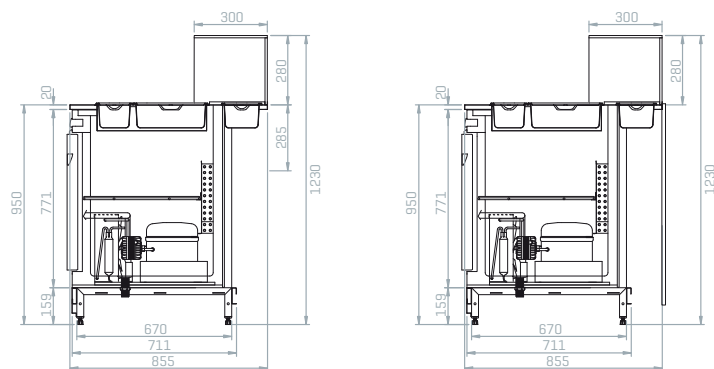

Base / Basic
Basis / Base

Pannellata / With panels
Mit Paneelen / Avec des panneaux

TOPPING 100

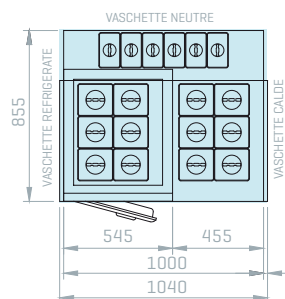

TOPPING 150

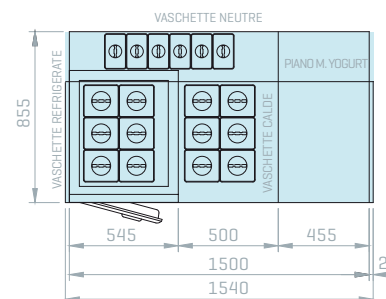

TOPPING 150

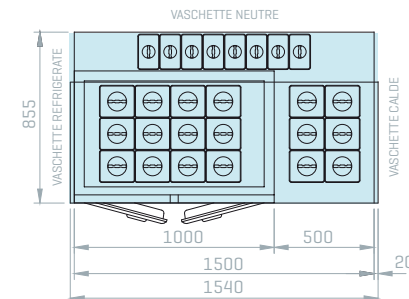

TOPPING 200

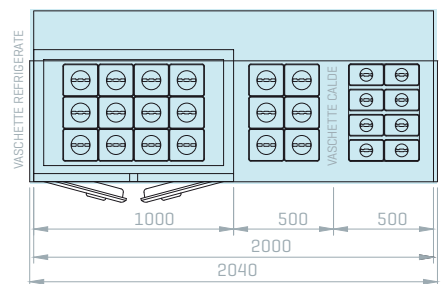

TOPPING 250

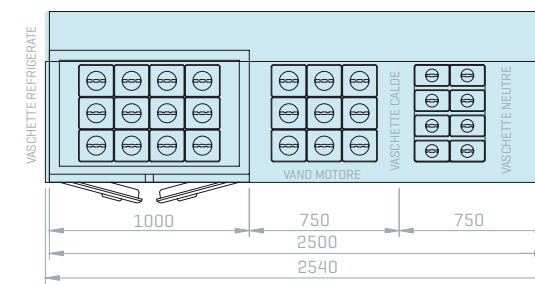

Struttura completamente in acciaio inox AISI 304. Piano di lavoro predisposto per vaschette e coperchi gastronom. Cella frigo sottostante TN ventilata.

ESCLUSO: teca vetro, rivestimento in legno laccato, illuminazione LED sul frontale, vaschette gastronom, impianto caldo e Bagno Maria.

Structure completely in S/s AISI304. Work top ready for gastronom lids and containers. Ventilated refrigerated cell in NT.

NOT INCLUDED: glass case, lacquered wood cover, frontal LED lights, gastronom containers, bain-marie and hot system.

Struktur vollständig aus Edelstahl AISI 304. Arbeitsplatte für Gastronom-Schalen und -Deckel vorbereitet. Umluft-Kühlzelle unter TN

AUSGENOMMEN: Glasheke, Verkleidung aus lackiertem Holz, LED-Beleuchtung an der Frontseite, Gastronom-Schalen, Wärmanlage und Wasserbad.

Structure entièrement en acier inox AISI 304. Plan de travail prévu pour les barquettes et les couvercles gastronom. Chambre froide dessous TN (température négative) ventilée.

EXCLUS: vetrine, revêtement en bois laqué, éclairage LED sur la façade, barquettes gastronom, installation chauffage et Bain-Marie.

COLORI / COLOURS / FARBEN / COULEURS



Le vetrine possono essere personalizzate nei colori RAL in commercio.
The showcase can be customized in colors according to available RAL.
Die Vitrinen können in handelsüblichen RAL-Farben gestaltet werden.
Les vitrines peuvent être personnalisées selon les coloris RAL dans le commerce.

TOPPING

Banco Guarnizioni con Riserva / Counter with Refrigeration and Storage

Theke für Garnierungen mit Reserve / Comptoirs Joints avec Réserve

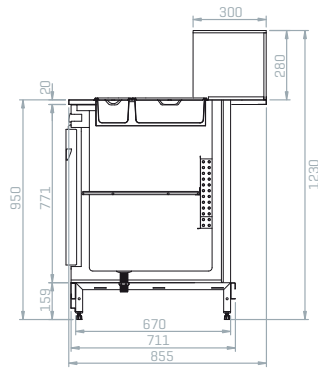

Base / Basic
Basis / Base

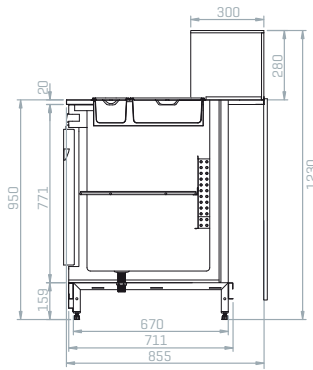

Pannellata / With panels
Mit Paneelen / Avec des panneaux

TOPPING 45° APERTO

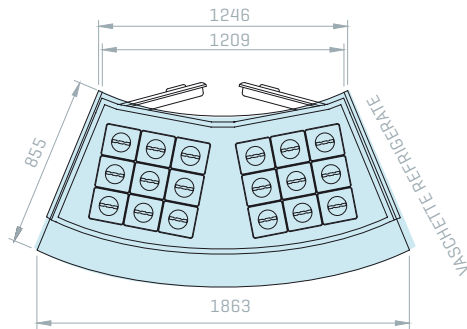

TOPPING 45° CHIUSO

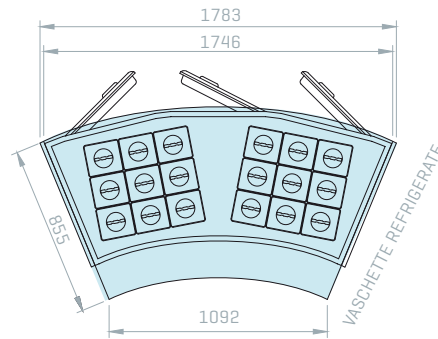

Banco Guarnizioni senza Riserva / Counter with Refrigeration without Storage

Theke für Garnierungen ohne Reserve / Comptoirs Joints sans Réserve

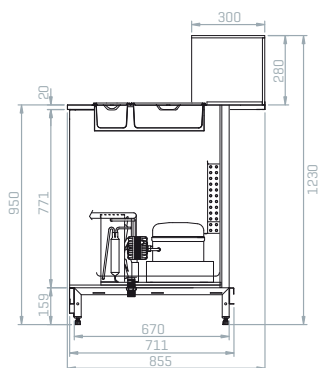

Base / Basic
Basis / Base

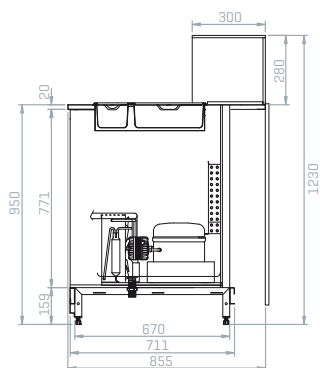

Pannellata / With panels
Mit Paneelen / Avec des panneaux

TOPPING 45° APERTO

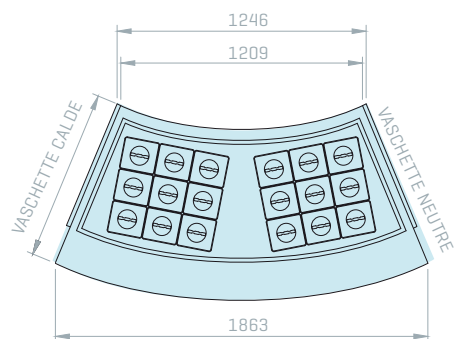

TOPPING 45° CHIUSO

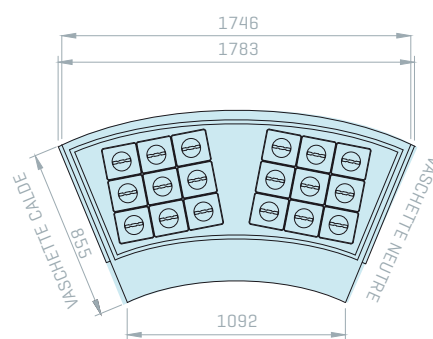

COLORI / COLOURS / FARBEN / COULEURS



Le vetrine possono essere personalizzate nei colori RAL in commercio.
The showcase can be customized in colors according to available RAL.
Die Vitrinen können in handelsüblichen RAL-Farben gestaltet werden.
Les vitrines peuvent être personnalisées selon les coloris RAL dans le commerce.

seguiaci su Facebook
Italproget



Bettona [Perugia] Italy | T. +39.075.9869071 | www.italproget.it |

AF DESIGN 02.10 - ICEVISION

ICEVISION

REV.1-02-2018

Italproget